

**Part # PJDI167(V)**  
**D14MZ520(V) - 9 GPM**  
**Injection Seal Kit**

(For serial #s  
13400000 up to 16290362)

**This kit contains:**

(1) JDI108	Side-inject connection o-ring
(2) JDI015	Side-inject o-rings
(1) JDI013	Check valve top seal
(1) JDI162	Side-inject o-ring
(1) JDI122	Stem o-ring
(1) JDI139	Plunger seal
(2) JDI100	O-rings for cylinder and sleeve
(1) PJDI118	Check valve assembly
(1) PJDI136	Plunger Valve Assembly
(1) PJDI161	Side-inject valve assembly



2090 Sunnysdale Blvd.  
Clearwater, FL 33765  
1-800-523-8499 • 1-727-443-5404  
www.dosatronusa.com

**Kit Contents**



JDI108 JDI015 JDI013



JDI162 JDI122 JDI139

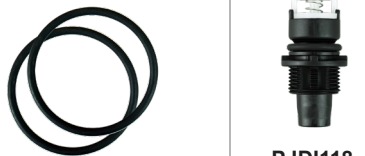

JDI100 PJDI118 (PJDI118V)



JDI156 JDI015 PJDI136 PJDI161



**CAUTION:** Used parts may contain concentrated chemicals. The use of Proper Protective Equipment is recommended when performing maintenance.

**INSTRUCTIONS**

(Parts noted in blue included in the kit)

1. Remove side-inject assembly. Unscrew nut (PDI702) and pull down on stem assembly (CDDI078) to detach.

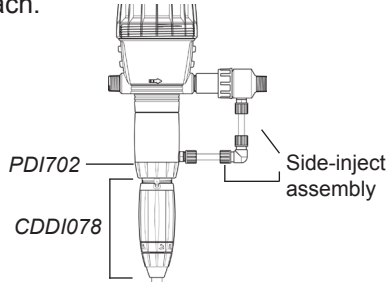

2. Remove hose nut (PDI748), check valve nut (PDI747), lock nut (PDI746), lock ring (PDI751) and adjusting nut (PPDI037).

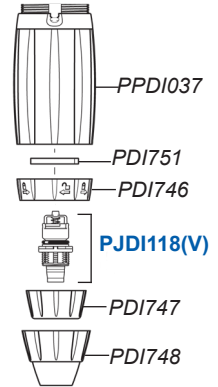

Remove check valve assembly (**PJDI118(V)**).

3. Push injection stem (PDI743) up from bottom of sleeve (PDI844). Replace o-ring (**JDI122**). Slide stem back into the sleeve, aligning long groove in stem with key in sleeve. Replace sleeve o-ring (**JDI100**). Slide nut (PDI702) on sleeve (PDI844) and screw adjusting nut (PPDI037).

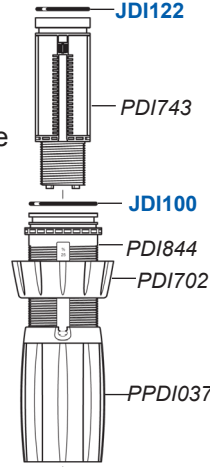

4. Reinstall locking ring (PDI751), make sure to align the molded keys with the grooves on the white stem. Reinstall locking nut (PDI746). Install new check valve assembly (**PJDI118(V)**), reinstall check valve nut (PDI747) and hose nut (PDI748). Set stem assembly aside.

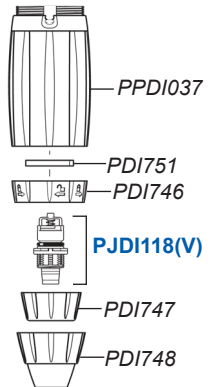

5. Remove bell housing (MPDI186) exposing piston (PCDI030). Set bell housing aside and make sure not to lose bell housing o-ring. Unscrew cylinder (PDI840) from top nut (PDI841) and pull down until plunger rod (PDI839) is exposed.

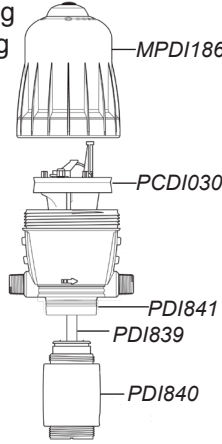

6. Hold piston (PCDI030) and turn rod (PDI839) one quarter of a turn counter-clockwise to detach from piston.

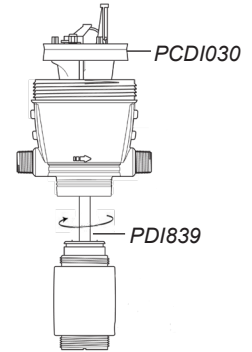

7. Remove nut (PDI705) and seal (**JDI013**) from top of side inject cylinder (PDI840).

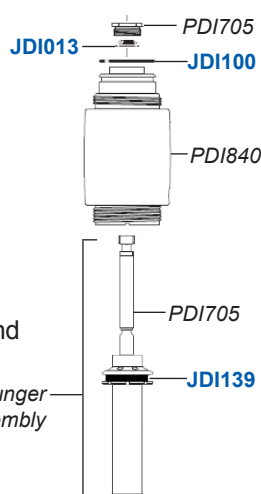

Remove plunger assembly from cylinder. Replace o-ring (**JDI100**) and (**JDI139**).

Plunger Assembly

8. Replace plunger seal (**JDI139**) from plunger assembly.

Remove beige nut (PDI843) and replace check valve assembly (**PJDI136**).

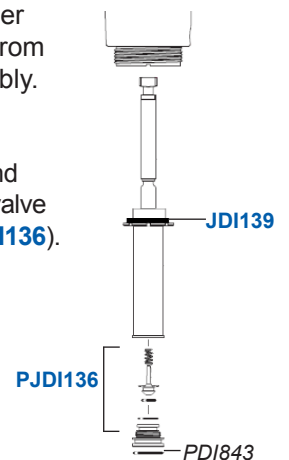

PJDI136

# INSTRUCTIONS

(Parts included in kit noted in blue)

9. Reinsert plunger assembly into side inject cylinder (PDI840).

Install new seal (**JDI013**) over plunger rod and reinstall nut (PDI705).

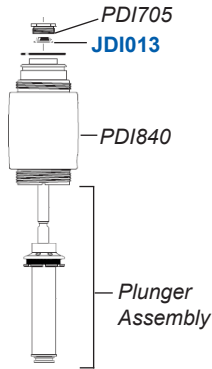

10. Reattach rod (PDI839) to piston (PCDI030) by inserting rod into slot in piston and turning one-quarter turn clockwise.

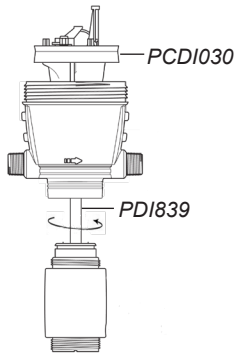

11. Push side inject cylinder (PDI840) up and screw into diffuser nut (PDI841), making sure the side-inject port lines up under the outlet port on the lower housing.

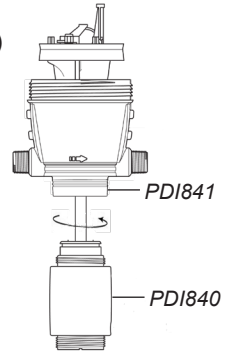

12. Reattach stem assembly (CCDI078) to cylinder (PDI840) by lining up molded keys on the stem with the notches on the threaded portion of the cylinder and pushing firmly up. Screw nut (PDI702) back on.

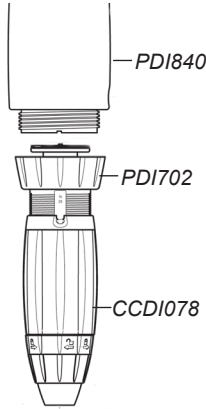

13. Reinstall bell housing (PDI685).

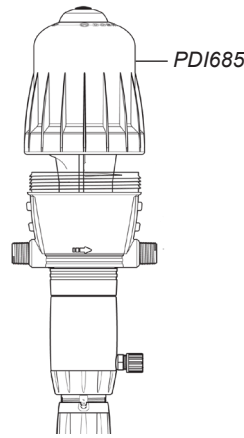

14. From lower part of side-inject cylinder (PDI840), remove connector (PJ149), replace o-ring (**JDI108**), then reinstall connector.

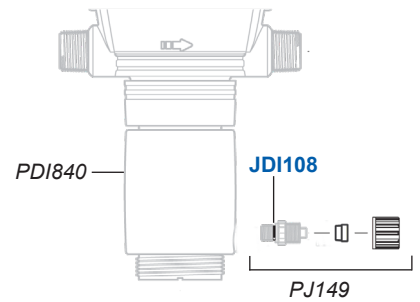

15. Remove connection (PJD1134) from the bottom of the side-inject assembly (PJD1132), replace o-ring (**JDI108**) and reinstall connection.

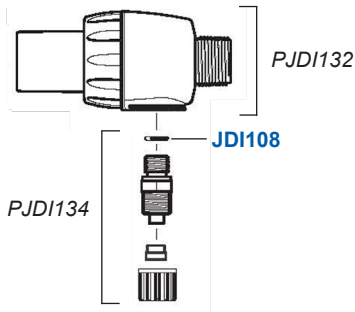

16. Unscrew nut (PDI901) and pull off side-inject threaded connector (PDI902) to expose spring-loaded check valve parts (**PJDI161**). Pull the *full assembly* out of the side inject body.

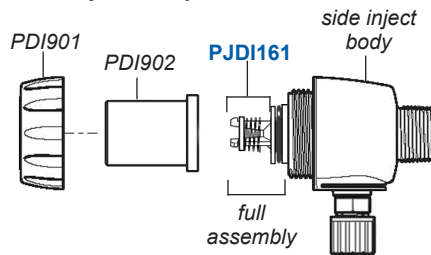

17. Discard check valve parts (**PJDI161**). Replace o-rings (**JDI015**) and (**JDI162**).

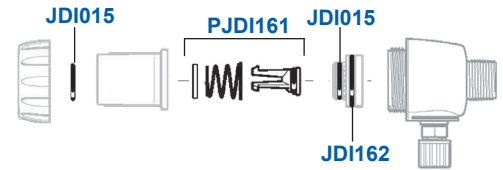

Assemble check valve parts (**PJDI161**) inserting the tines through the wider end of spring, then through the plastic washer. Place the check valve back inside the white piece.

18. Insert the *full assembly* back into the *side inject body*. Reinstall the threaded connector (PDI902), and nut (PDI901) with o-ring (**JDI015**) in place.

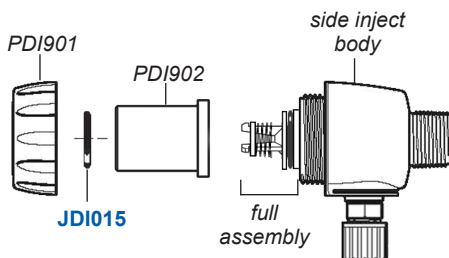

19. Re-connect the side inject assembly, with tubing and ports, back to the body.

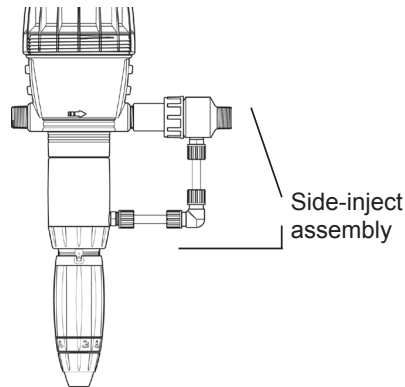

Seal kit for units with serial #s 13400000 up to 16290362 only.

Always be careful not to overtighten any parts.

Remember to set your injection rate to the proper ratio.



LIT-EN-PJD1167