



DOSATRON®

An Ingersoll Rand Business



D45RE15-IE - 20 GPM ESQUEMAS INTERACTIVOS

ESPECIFICACIONES

- 1:500 - 1:66
- 7 -70 PSI
- Conexión 1" NPT

RECOMENDACIONES

- Filtro de malla de 200/80 micrones antes de la unidad

INSTRUCCIONES

- Haga clic en el # de parte, para visitar la página
- Regrese a este documento con la flecha

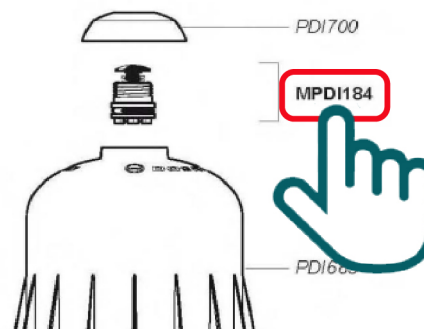

D45RE1.5-IE

4.5 m³/h - 0.2 - 1.5%
20 GPM - 1:500 - 1:67
0.5 - 5 bar
7 - 70 psi

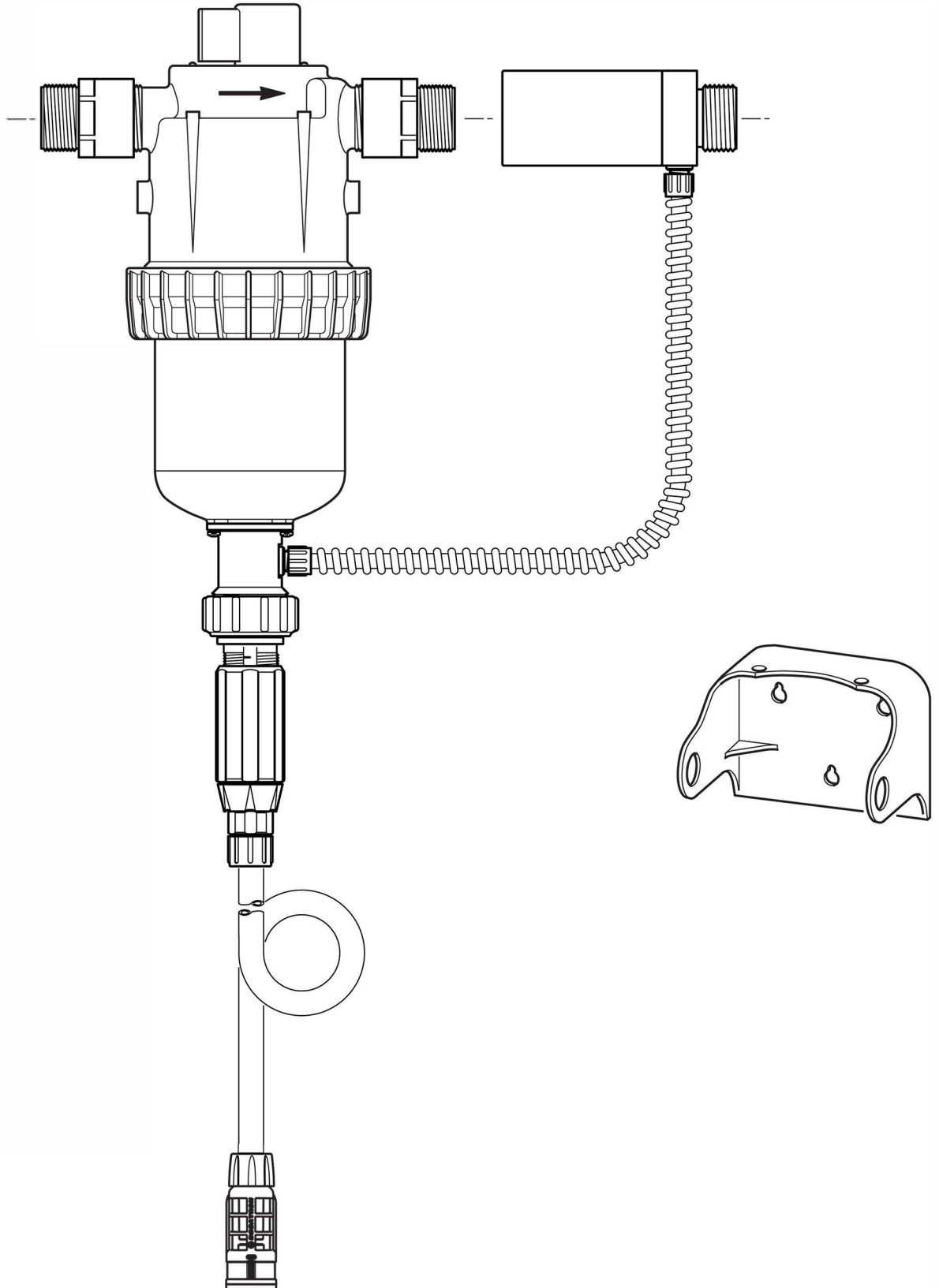

D45RE1.5-IE

4.5 m³/h - 0.2 - 1.5%
20 GPM - 1:500 - 1:67
0.5 - 5 bar
7 - 70 psi

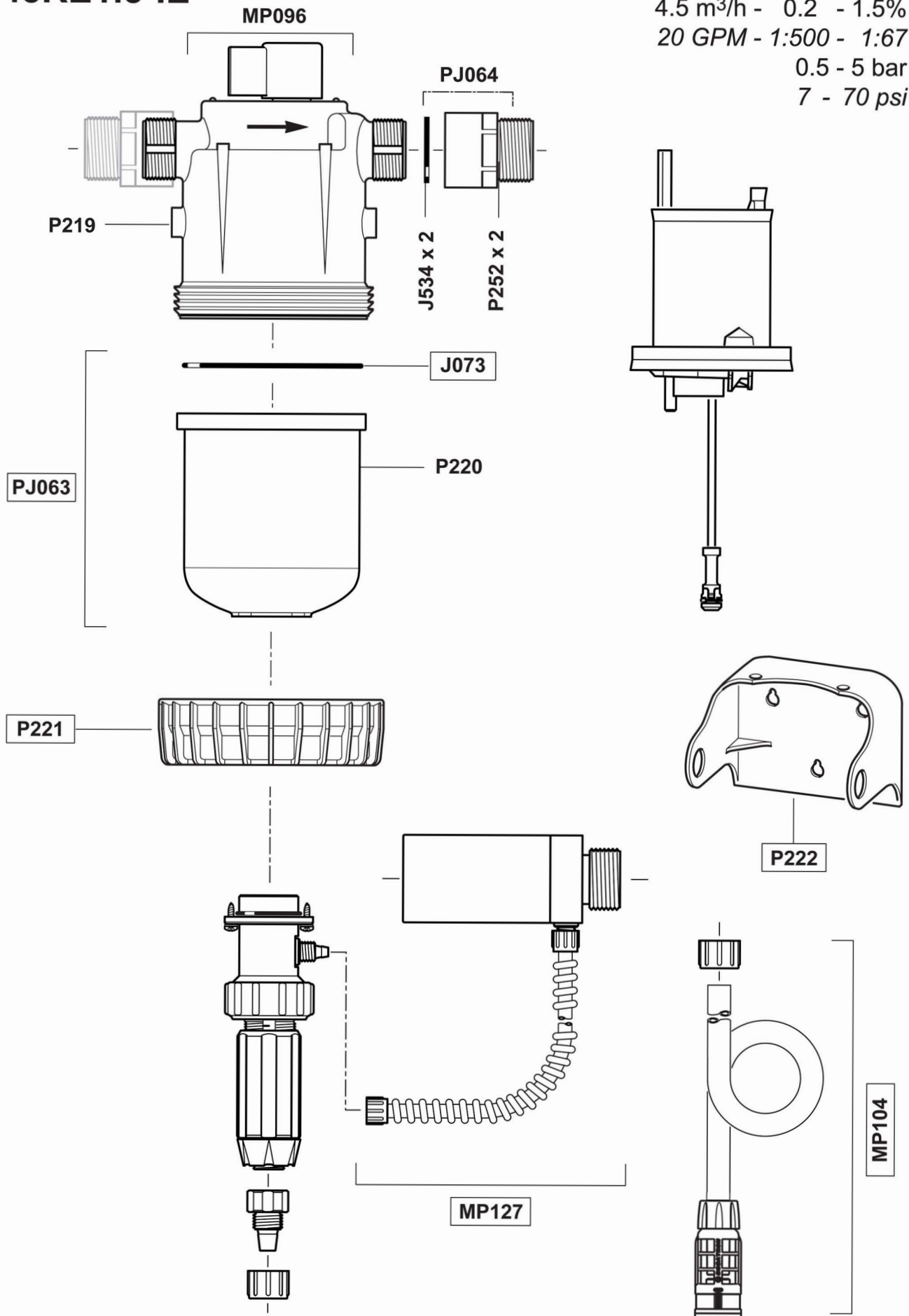

D45RE1.5-IE

4.5 m³/h - 0.2 - 1.5%
20 GPM - 1:500 - 1:67
0.5 - 5 bar
7 - 70 psi

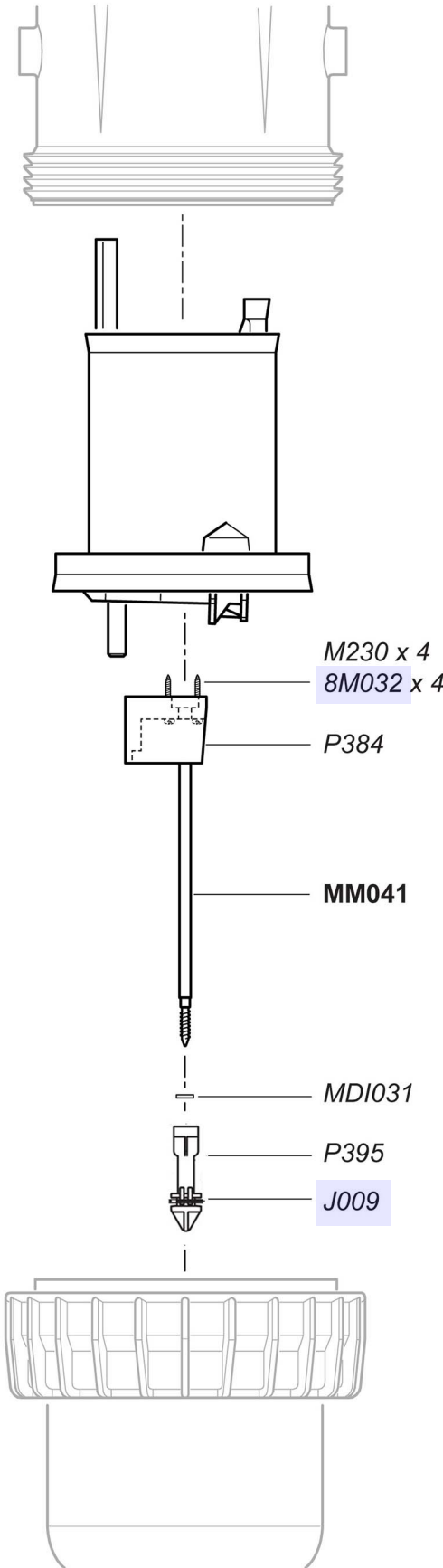

D45RE1.5-IE

4.5 m³/h - 0.2 - 1.5%
 20 GPM - 1:500 - 1:67
 0.5 - 5 bar
 7 - 70 psi

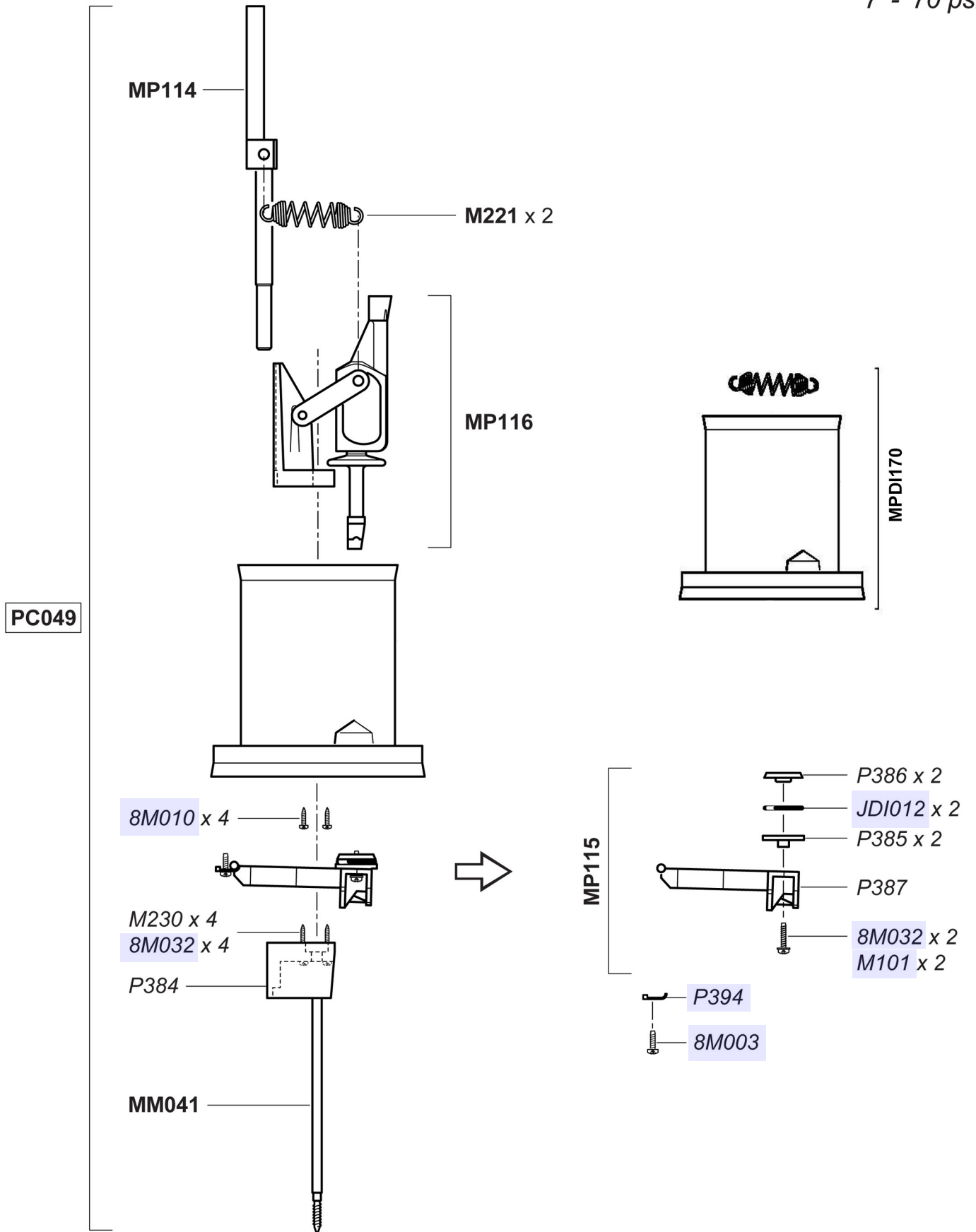

D45RE1.5-IE

4.5 m³/h - 0.2 - 1.5%
 20 GPM - 1:500 - 1:67
 0.5 - 5 bar
 7 - 70 psi

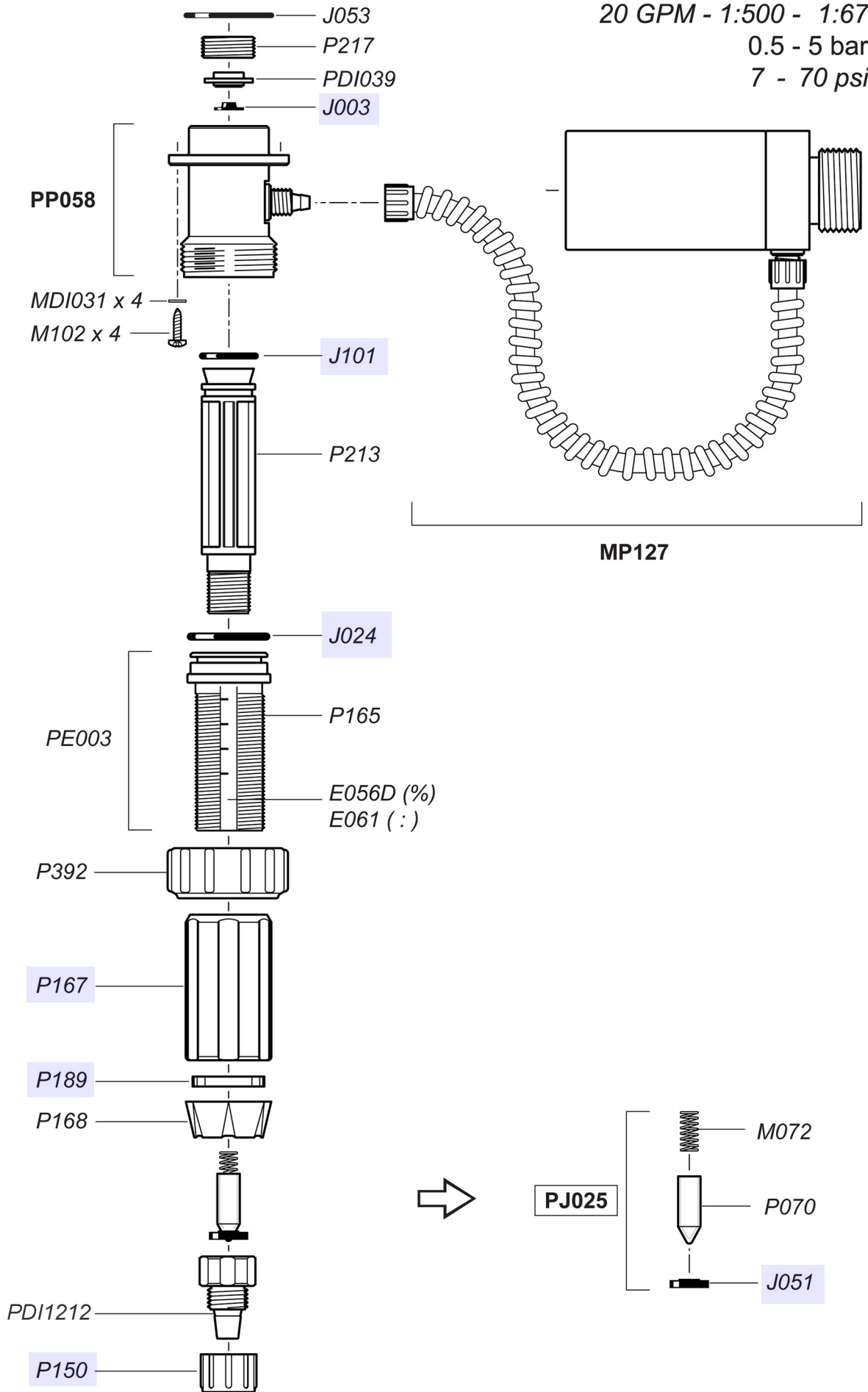

D45RE1.5-IE

4.5 m³/h - 0.2 - 1.5%
20 GPM - 1:500 - 1:67
0.5 - 5 bar
7 - 70 psi

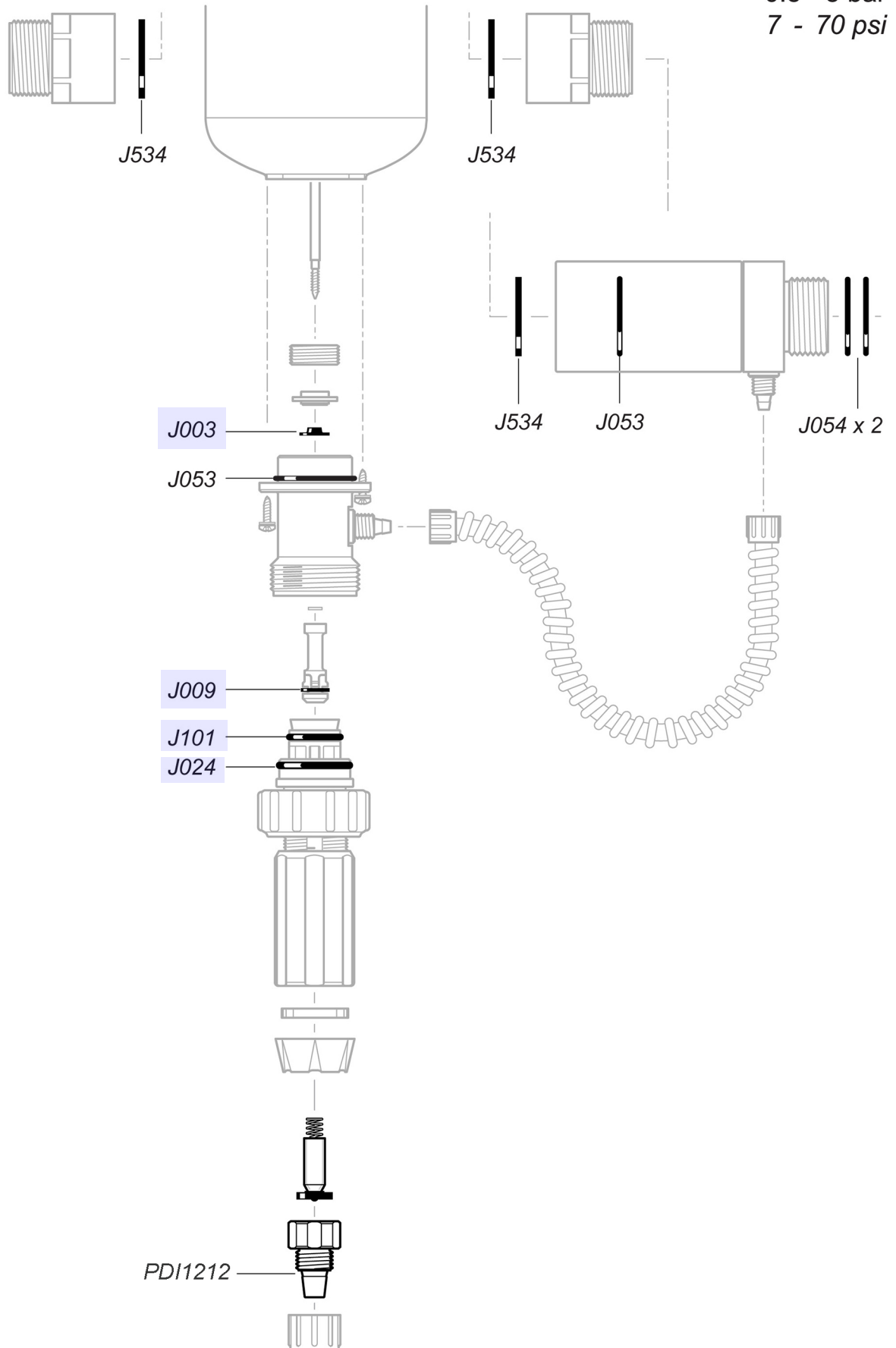

D45RE1.5-IE

4.5 m³/h - 0.2 - 1.5%
20 GPM - 1:500 - 1:67
0.5 - 5 bar
7 - 70 psi

